

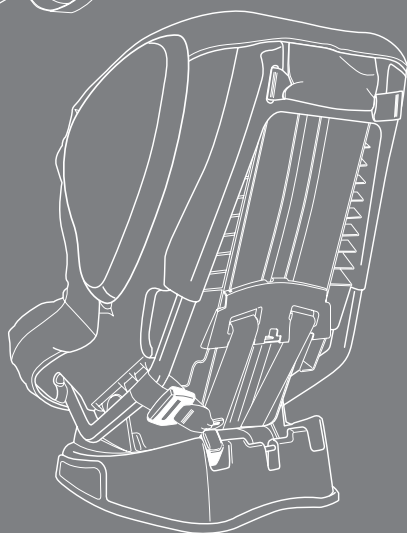

Advocate[®] 70 CS

User Guide

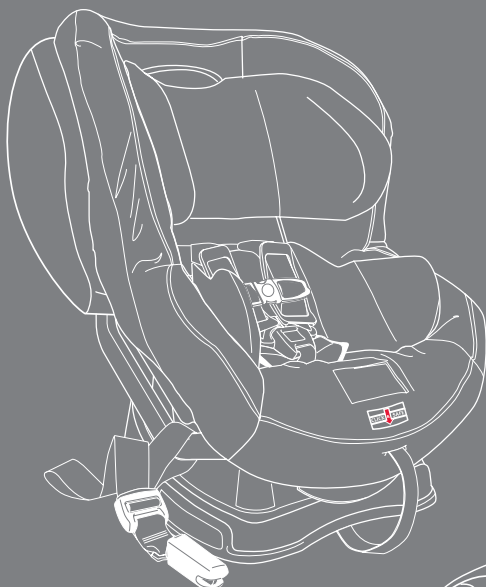

Para obtener instrucciones en español, favor visitar nuestra página web:
www.britaxusa.com/instrucciones-en-espanol o favor llamar al 1 704.409.1700



IMPORTANT: Thoroughly read and follow all instructions before installing this child seat. Store this user guide in the pocket behind the cover (See features pages for reference).

Safety Information	2
Warnings	2
Important Notes	3
Certification	4
Registration	4
Important Child Seat Usage Information	4
Vehicle Compatibility	6
Compatible Vehicle Seat Belts	6
Incompatible Vehicle Seat Belts	8
Vehicle Seating Positions	9
Child Seat Features	10
Child Seat Functions	12
Click & Safe® Snug Harness Indicator	12
Adjusting the Harness Height.....	13
Adjusting the Buckle Position	13
Fastening the Buckle.....	14
Releasing the Buckle.....	14
Using the Chest Clip	14
Using the Lock-Offs	14
Infant Body Pillow	15
Recline Positions	15
Using the Lower Anchors and Tethers for Children (LATCH)	16
Using the Lower Connectors	17
Using the Versa-Tether®	17
Rear-Facing Installation	20
LATCH Installation	20
Lap-Shoulder Belt Installation.....	22
Lap Belt Installation	24
Forward-Facing Installation	26
LATCH Installation	26
Lap-Shoulder Belt Installation.....	28
Lap Belt Installation	30
Aircraft Installation	32
Securing Your Child	33
Care and Maintenance	34
Tips and Troubleshooting	40
Warranty	41

WARNING!

DEATH or SERIOUS INJURY can occur:

- Use only in a rear-facing position when using it with an infant weighing less than 20 lbs (9.1 kg).
- Use only with children who weigh between 5 and 70 lbs (2.3 – 31.8 kg) and whose height is 49 in. (124.5 cm) or less. Use rear-facing for children who weigh between 5 and 40 lbs (2.3 – 18.1 kg). Use forward-facing for children who weigh between 20 and 70 lbs (9.1 – 31.8 kg).
- Snugly adjust the belts provided with this child restraint around your child. A snug strap should not allow any slack. It lies in a relatively straight line without sagging. It does not press into the child's flesh or push the child's body into an unnatural position.
- Secure the top anchorage strap provided with this child seat.
- Secure this child restraint with the vehicle's child restraint anchorage system if available, or with a vehicle seat belt.
- Follow all instructions on this child restraint and in the written instructions located in the pocket behind the cover.
- Register your child restraint with the manufacturer.
- This child seat must be reclined to position 3 when installed rear-facing (see page 15).
- Use the inner buckle slot when installed rear-facing.
- Use the outer buckle slot when installing the child seat forward-facing with a child weighing 30 lbs (13.6 kg) and above or if the buckle is under the child in the inner position.
- When installing in forward-facing mode this child seat must be in position 1 or position 2 (see page 15).
- HUGS™ chest pads must be used in forward-facing mode. Removal of HUGS is optional only for rear-facing mode.
- To prevent injury due to deterioration or hidden damage, discontinue use of this child seat if it is older than seven years or has been in a moderate or severe crash (see page 3). See *Serial Number and Manufactured Date Label* on child seat (page 11).
- This child seat must not be used in the home, in boats, or other non-certified applications.
- Based on crash statistics, the National Highway Traffic Safety Administration (NHTSA) recommends that parents select the back seat as the safest location for a properly installed child seat. Please study *Vehicle Seating Positions* on page 9 to ensure your child's safety and consult your vehicle owner's manual.
- Secure this child seat even when it is not occupied. In a crash, an unsecured child seat may injure vehicle occupants.
- When using in a vehicle with air bags, refer to your vehicle owner's manual for child seat installation instructions and precautions.
- Never use the harness adjuster strap to lift or carry this child seat. Doing so could cause damage to harness adjuster and webbing. Always carry this child seat by its shell or tether straps.

- The primary protection for occupants of a vehicle in a collision is the body of the vehicle itself; a child seat will not protect a child when a vehicle is seriously impacted. However, correctly installed, a child seat will substantially improve chances for survival in most crashes. Make sure all users fully understand the correct ways to use this child seat in a vehicle.
- Refer to your vehicle owner's manual or contact the vehicle manufacturer for the maximum weight rating for their lower anchors. Use vehicle seat belt (not lower connectors) for installations with children who weigh more than the vehicle lower anchor limit. Unless specified otherwise by the vehicle manufacturer, assume a 40 lb (18.1 kg) child is the vehicle lower anchor limit.
- Prevent the Side Impact Cushions from being punctured. Puncture damage will cause the cushions not to perform as intended in a crash.
- The use of non-Britax Child Safety, Inc., covers, inserts, toys, accessories, or tightening devices is not approved by Britax. Their use could cause this child seat not to perform as intended in a crash.

Important Notes

- Verify that the child seat is securely installed and the harness is properly adjusted around the child each time the child seat is used.
- Discontinue use of this child seat if it has been in a moderate or severe crash. It is not necessary to replace a car seat after a **minor** crash defined by the US National Highway Traffic Safety Administration (NHTSA) as:
 - * The vehicle is driveable from the crash site; *and*
 - * The vehicle door nearest the child seat was not damaged; *and*
 - * No vehicle occupants were injured; *and*
 - * There is no visible damage to the child seat; *and*
 - * The airbags (if present) did not deploy.
- Adjust the harness to fit the clothes the child is wearing. Remove bulky coats and/or jackets before putting the child in child seat.
- Cover the child seat when the vehicle is parked in direct sunlight. Metal parts of child seat could become hot enough to burn a child.
- Store the child seat in a safe place when it is not being used. Avoid placing heavy objects on top of it.
- Do not leave children alone in a vehicle, even for a short time.
- Do not, except as described in this booklet, attempt to disassemble any part of the child seat or change the way the harness or vehicle's seat belts are used.
- Do not leave loose objects, e.g. books, bags, etc., in the back of a vehicle. In the event of a sudden stop, loose objects will keep moving, potentially causing serious injuries.
- Do not leave folding vehicle seats unsecured or unlatched. In the event of a sudden stop, a loose seat back could cause the child seat not to perform as intended.
- Do not allow children to play with this child seat.
- Do not use anything to raise the child seat off vehicle seat except as described in these instructions. Their use could cause the child seat not to perform as intended in a crash.

Certification

This child seat system conforms to all applicable Federal Motor Vehicle Safety Standards (FMVSS 213). **This Restraint is Certified For Use in Motor Vehicles and Aircraft.**

Registration

Child restraints could be recalled for safety reasons. You must register this restraint to be reached in a recall. Send your name, address, e-mail address if available and the restraint's model number and manufacturing date to Britax Child Safety, Inc. P.O.Box 91167 Allentown, PA 18109-9925, or call 1-888-427-4829, or register online at www.BritaxUSA.com/registration. For recall information, call the U.S. Government's Vehicle Safety Hotline at 1-888-327-4236 (TTY 1-800-424-9153), or go to <http://www.NHTSA.gov>.

For your convenience, record all the information about your child seat below. Refer to the Serial Number & Manufactured Date Label for all information, see page 11.

Model Name and Number: _____

Serial Number: _____

Batch Number: _____

Date of Manufacture: _____

Important Child Seat Usage Information

Rear-Facing: 5 – 40 lbs (2.3 – 18.1 kg)

American Academy of Pediatrics recommends: All infants and toddlers should ride in a Rear Facing Car Seat until they are 2 years of age or until they reach the highest weight or height allowed by their car safety seat's manufacturer.

Britax strongly recommends that children ride rear-facing to the highest weight or height specified.



WARNING! REAR-FACING use of this child seat is **ONLY** for children who meet **ALL** of the following requirements. If the child cannot be secured within these requirements because they are too small, use of the infant positioning insert or selection of a different child seat (such as an infant car seat) may be required. If the child cannot be secured within these requirements because the child is too large, review the forward-facing guidelines on page 5.

An infant positioning insert may be necessary for small infants to achieve a snug fit if the child is under 12 lbs (5.4 kg) and the lowest harness slots fall above the infants shoulders. The infant positioning insert is sold separately at select retailers and on www.britaxusa.com.

Use rear-facing with children:

- who weigh 5 – 40 lbs (2.3 – 18.1 kg) **and**
- when the top of the child's head is at least 1 in. (2.5 cm) below the top of the child seat shell (Fig. A) **and**
- when the harness straps are at or slightly below the child's shoulders (Fig. A).



IMPORTANT: See [Adjusting the Harness Height](#) on page 13.

Forward-Facing: 20 – 70 lbs (9.1 – 31.8 kg)

Britax strongly recommends that children should be secured with a harness system until they exceed the weight or height limits specified.



WARNING! FORWARD-FACING use of this child seat is **ONLY** for children who meet **ALL** of the requirements below. If the child cannot be secured within these requirements because they are too large, another type of child seat (such as a booster) may be required. If the child cannot be secured within these requirements because the child is too small, review the rear-facing information above.

Use forward-facing only with children:

- who weigh 20 – 70 lbs (9.1 – 31.8 kg) **and**
- who are 49 in. (124.5 cm) or less in height **and**
- when the top of the ears are below the top of the child seat shell **and**
- when the harness straps are at or above the child's shoulders, parallel to level ground (Fig. B).

IMPORTANT: When using position 2, it may be necessary to adjust the harness to a higher position than when the seat is in position 1. See [Adjusting the Harness Height](#) on page 13.

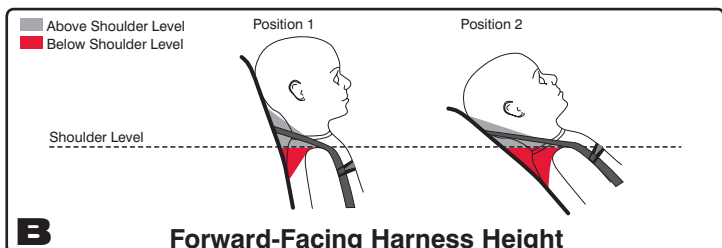

Compatible Vehicle Seat Belts

NOTE: The information in this section only applies to installation with vehicle seat belts.

Vehicle seats and seat belts differ from vehicle to vehicle. Refer to your vehicle owner's manual for specific information about your vehicle seat belts and their use with child seats.

Lap-Shoulder (3-Point) Belt

1. ALR (Automatic Locking Retractor) with Sliding Latch Plate

- a** Has a latch plate that freely slides along the vehicle seat belt webbing.

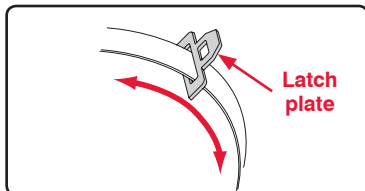

- b** Has a retractor that stops the belt from being pulled out again once the belt webbing has been pulled out at least 24 in. (61 cm).



- c** Tightens by feeding the belt webbing back into the retractor.

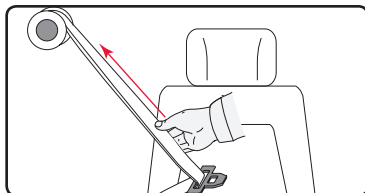

2. ELR (Emergency Locking Retractor) with Locking Latch Plate

- a** Has a latch plate that locks the vehicle belt.

* This type of latch plate locks the vehicle belt when the vehicle belt and latch plate lie flat. When using this type of vehicle belt with a child seat, ensure the latch plate and vehicle belt lie flat against the child seat or the vehicle belt may remain unlocked.

- b** Has a retractor that locks only in an emergency situation such as sudden stop or crash.

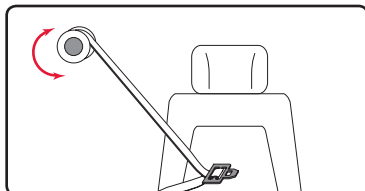
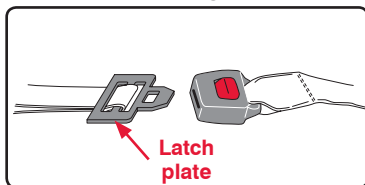

3. Switchable Retractor in ALR Mode with Sliding Latch Plate

- a** Has a latch plate that freely slides along the vehicle seat belt webbing.

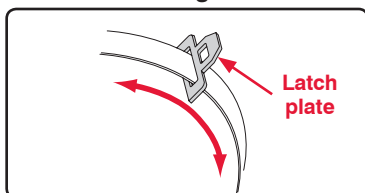

- b** Has a retractor that can be switched to function as an ALR. Pull the belt all the way out of the retractor to set the automatic locking function.

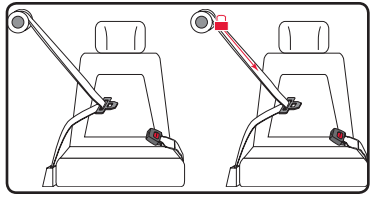

- * To use a child seat with this type of vehicle seat belt, you will need to switch to the ALR mode or use child seat lock-offs.

4. ELR (Emergency Locking Retractor) with a Sliding Latch Plate

- a** Has a latch plate that freely slides along the vehicle seat belt webbing.
- b** Has a retractor that locks only in an emergency situation such as sudden stop or crash.

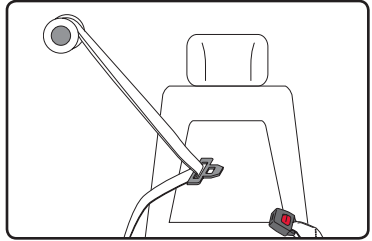

IMPORTANT: This belt type requires the use of the lock-offs built into the seat for rear- and forward-facing installations. See page 14 for information on using the lock-offs.

Lap Belt

5. ALR (Automatic Locking Retractor)

- a** Has a latch plate that is sewn into the webbing.
- b** Has a retractor that stops the belt from being pulled out again once the belt webbing has been pulled out at least 24 in. (61 cm).

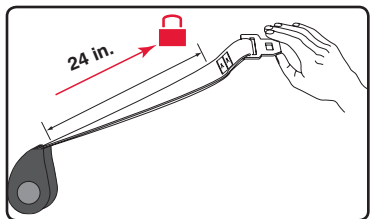
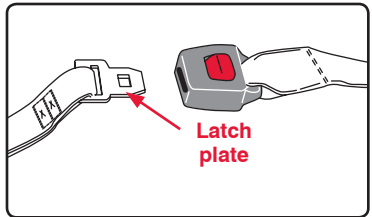

- c** Tightens by feeding the belt webbing back into the retractor.

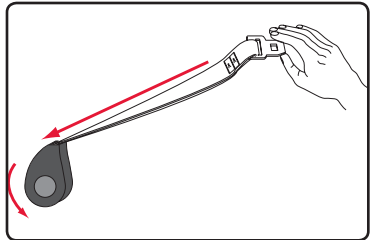

6. Locking Latch Plate

a Has a latch plate that prevents the webbing from becoming loose.

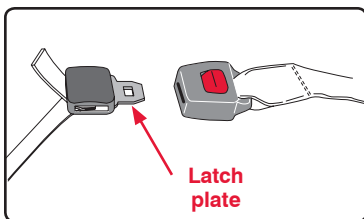

b Tightens by pulling on the belt webbing.

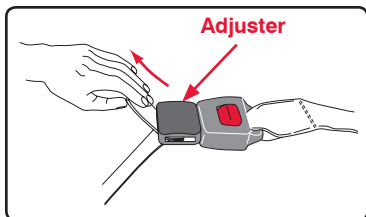

Incompatible Vehicle Seat Belts



WARNING! The following types of vehicle seat belts are **NOT** compatible with this child seat. If any of the belt types listed below are in the chosen seating position, choose another vehicle seating position or check your vehicle owner's manual for information on installing a car seat in your vehicle.



1 Lap-shoulder belts with top or bottom anchor points on the vehicle door.



2 Motorized, automatic vehicle seat belts.



3 Lap-shoulder belts that have a separate retractor each for the lap section and shoulder section.



4 Inflatable lap-shoulder belts.



5 Lap belts forward of the vehicle seat bight.



6 Lap belts with a sewn-in latch plate that have a retractor that locks only in case of a sudden stop.

Vehicle Seating Positions**WARNING!**

DO NOT place child seat rear-facing in the front seat of a vehicle with a passenger air bag unless deactivated. DEATH or SERIOUS INJURY can occur. See your vehicle owner's manual for child seat installation instructions. The back seat is the safest place for children 12 and under.

Some vehicles have no seating positions which are compatible with this child seat. If in doubt, contact the vehicle manufacturer for assistance.

Forward-facing vehicle seats MUST be used with this child seat. Side-facing or rear-facing seats CANNOT be used. See the diagram below.

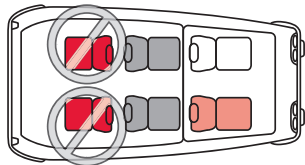
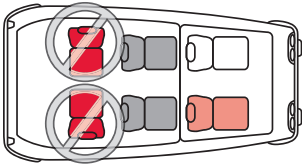
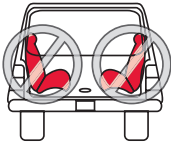

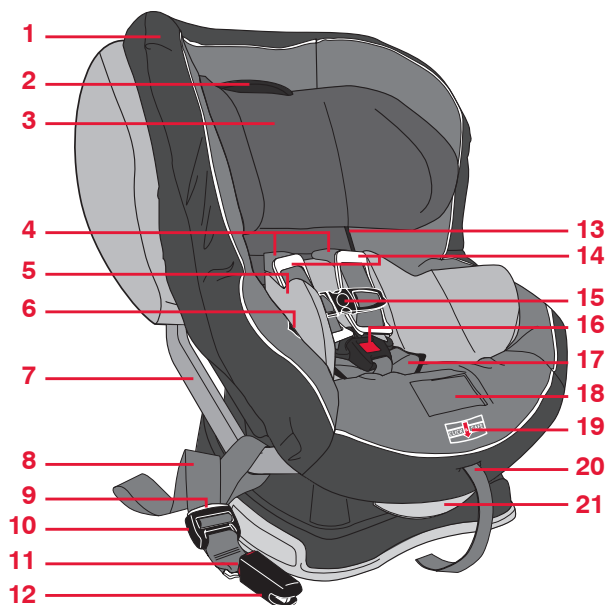

- 1 Cover
- 2 Harness Height Adjuster
- 3 Head Restraint
- 4 Comfort Pads
- 5 Infant Body Pillow
- 6 Harness Holder
- 7 Lower Connector Bar
- 8 Lower Connector Strap (LATCH component)
- 9 Lower Connector Adjuster Release Button (LATCH component)
- 10 Lower Connector Adjuster (LATCH component)
- 11 Lower Connector Release Button (LATCH component)
- 12 Lower Connector (LATCH component)
- 13  User Guide Storage (in pocket behind cover)
- 14 HUGS™ (Harness Ultra Guard System) Chest Pads
- 15 Chest Clip
- 16 Harness Buckle
- 17 Belly Pad
- 18 Harness Adjuster Lever (under cover)

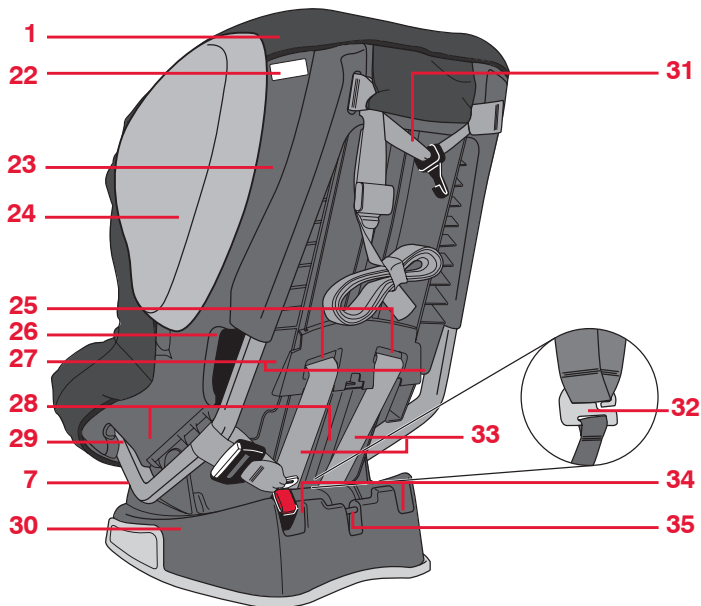

- 19 Click & Safe® Snug Harness Indicator (under cover)
- 20 Harness Adjuster Strap
- 21 Recline Adjustment Handle
- 22 Serial Number & Manufactured Date Label
- 23 Shell
- 24 Side Impact Cushion
- 25 Harness Slots
- 26 Forward-Facing Belt Slot
- 27 Forward-Facing Lock-Offs (Red – under cover on front of shell)
- 28 Rear-Facing Lock-Offs (Blue – under cover on front of shell)
- 29 Rear-Facing Belt Slot
- 30 Base
- 31 Versa-Tether® (Top Anchorage Strap - LATCH component)
- 32 Harness Yoke
- 33 Harness Straps
- 34 Lower Connector Storage
- 35 Versa-Tether® Carry Clip

Click & Safe® Snug Harness Indicator

IMPORTANT: See pages 32 – 33 for detailed instructions on securing your child.

The Click & Safe® is an audible indicator to help determine when the child seat harness is within range of appropriate snugness. The Click & Safe is a secondary feature. Parents should be aware of what amount of snugness is appropriate in the harness. The harness should have a comfortable but snug fit around the child. A snug strap should not allow any slack. It lies in a relatively straight line without sagging. It does not press on the child's flesh or push the child's body into an unnatural position. You should not be able to pinch excess.

The Click & Safe is designed to sense tension when the adjuster strap is pulled. Ensure all slack has been removed from the child's hips and that the harness straps are correctly positioned at the child's shoulders so the Click & Safe will provide the most accurate reading. Follow the steps below to tighten the harness.

To tighten the harness:

- 1 Remove any bulky clothing from your child before tightening the harness.
- 2 Check for proper harness height.

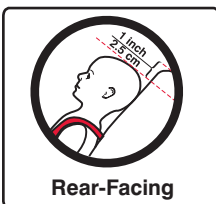

- 3 Remove slack in the harness from around child's upper thighs.
- 4 Remove slack in the harness between the HUGS™ chest pads and buckle.
- 5 Pull the harness adjuster strap up and away from the child seat until a click is heard. **The Click & Safe® indicator will click when the harness is within range of appropriate snugness.**

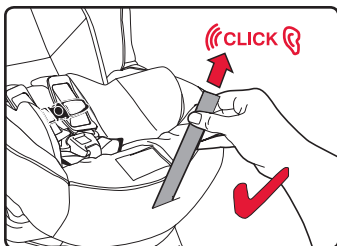

NOTE: If there is still slack in the harness, repeat steps 1–4 then pull the adjuster strap up and away from the child seat again until another click indicates a snug harness. It may be necessary to double check to confirm that the harness is within range of appropriate snugness. Always confirm a snug fit by attempting to pinch excess webbing.



Checklist

- ✓ Check that the harness is buckled and secure.
- ✓ Check that the harness is snug and you can not pinch excess.

Adjusting the Harness Height

- 1 *Loosen the harness.*
 - a Lift harness adjuster lever
 - b Pull both harness straps forward
- 2 *Squeeze the harness height adjuster, slide the harness into the desired position and release.*
 - * Ensure the harness has locked into position.

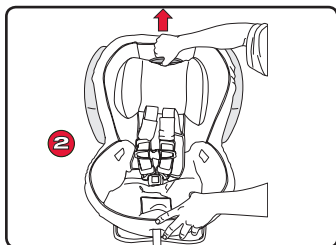
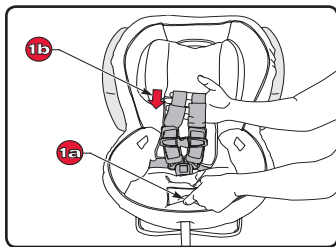

NOTE: In rear-facing mode, always position the harness straps at or **below** your child's shoulders. See pages 4 – 5.

In forward-facing mode, always position the harness straps at or **above** your child's shoulders. See page 5.

Adjusting the Buckle Position

IMPORTANT:

- ALWAYS position the buckle in the inner slot for rear-facing use when using a vehicle seat belt installation.
- The vehicle belt must pass in front of the buckle strap for rear-facing use.
- Position the buckle in the slot closest to but not under the child for rear-facing use when using the LATCH installation.
- NEVER leave the buckle in the adjustment slot.
- Use the outer buckle slot when installing the child seat forward-facing with a child weighing 30 lbs (13.6 kg) and above or if the buckle is under the child in the inner position.

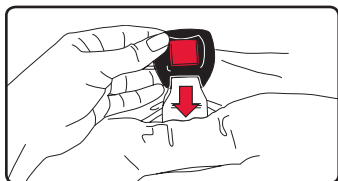
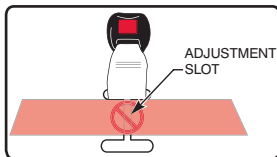

- 1 *Unbuckle the harness. Remove the belly pad and push the buckle through the cover.*

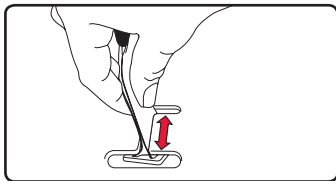

- 2 *Turn the buckle webbing and slide it between buckle positions.*

- 3 *Slide the buckle retainer into the buckle slot, and ensure the red release button faces out.*

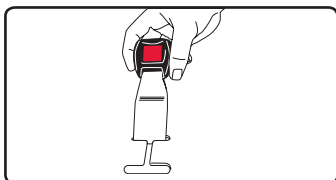

Fastening the Buckle

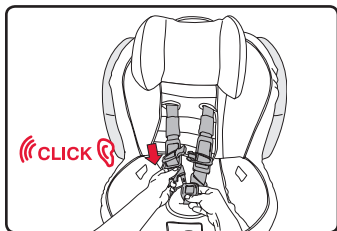

Insert one tongue at a time into the buckle.

NOTE: Proper connection is confirmed with a click after inserting each buckle tongue.

Releasing the Buckle

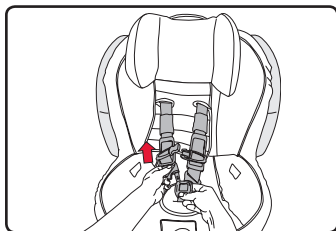

Press the release button and pull the tongues from the buckle.

NOTE: Periodically clean the buckle to ensure proper operation. See page 38.

Using the Chest Clip

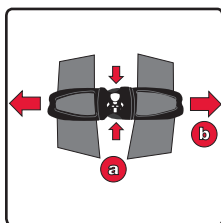

1 Open the chest clip.

- a Press tabs
- b Pull apart

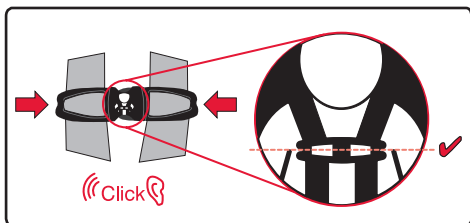

2 Push together to fasten.

NOTE: Always position the chest clip at armpit level.

Using the Lock-Offs

IMPORTANT: Both parts of the lock-off must be opened to secure a vehicle belt.

To Open:

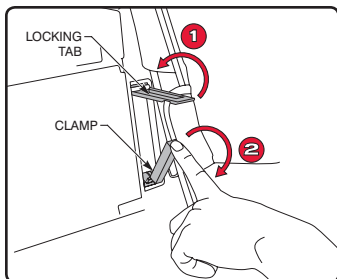

- 1 Open the locking tab.
- 2 Open the clamp.

To Close:

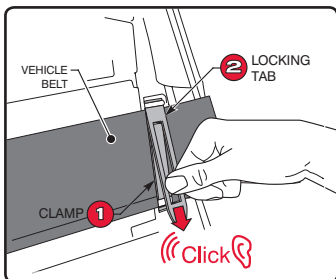

- 1 Close the clamp over the vehicle belt.
- 2 Slide your palm or thumb along the locking tab until a click is heard.

Infant Body Pillow

The infant body pillow is designed to provide better fit and comfort for infants using this child seat. Fold the flaps in for additional side support.

NOTE: Remove the infant body pillow after the child can sit comfortably in the child seat without additional support.

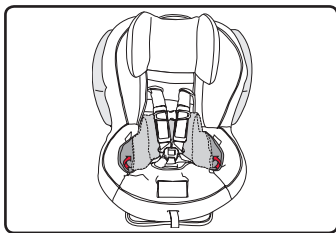

Recline Positions

This child seat has 3 positions. To adjust, pull the recline handle then rotate the child seat shell into the desired position. Release the recline handle, then verify the child seat has locked into position.

NOTE: Set the recline position **BEFORE** installing.

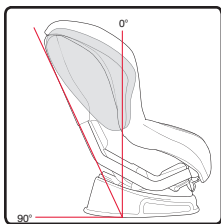

Position 1

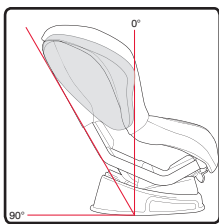

Position 2

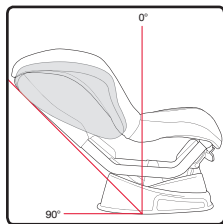

Position 3

Rear-Facing

When installed in the rear-facing position, the child seat should be reclined at least 30° from vertical for children and up to 45° from vertical for infants unable to maintain head and neck control (not to exceed 45°) when the car is parked on a level surface. When installing the seat in rear-facing mode, recline the seat to position 3 and use the guide line on the child seat to help achieve an acceptable recline angle for rear-facing installations.

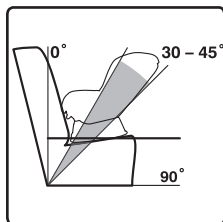

Forward-Facing

IMPORTANT: In forward-facing installations, it is important that the base of the child seat rests completely flat on the vehicle seat. As illustrated below, it is permissible to allow up to 20% or 3 in. (7.6 cm) of the base to hang over the edge of the vehicle seat. Some vehicle seats do not allow enough of the child seat base to contact the vehicle seat. If this is the case, adjust the recline angle to a more upright position. Not doing so could cause the child seat not to perform as intended.

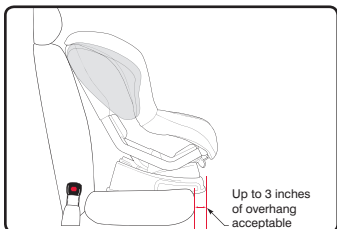

Acceptable overhang

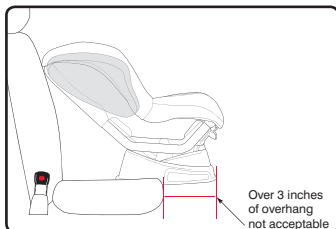

Unacceptable overhang



WARNING! In some cases, the vehicle head restraint can prevent the child seat head restraint from being raised high enough to properly adjust the harness for the fit of your child when using a forward facing reclined position. **DO NOT** force the child seat head restraint past the vehicle head restraint. Doing so could cause the child seat not to perform as intended. If the location of the vehicle head restraint interferes with the child seat head restraint, raise or remove the vehicle head restraint. If the vehicle head restraint cannot be removed, move the child seat to the upright position or try a different seating location.



Using the Lower Anchors and Tethers for Children (LATCH)

The Lower Anchors and Tethers for Children or LATCH, is a system available on this child seat that offers an alternative to vehicle seat belt installation methods. See pages 10 and 11 for LATCH components on this child seat.

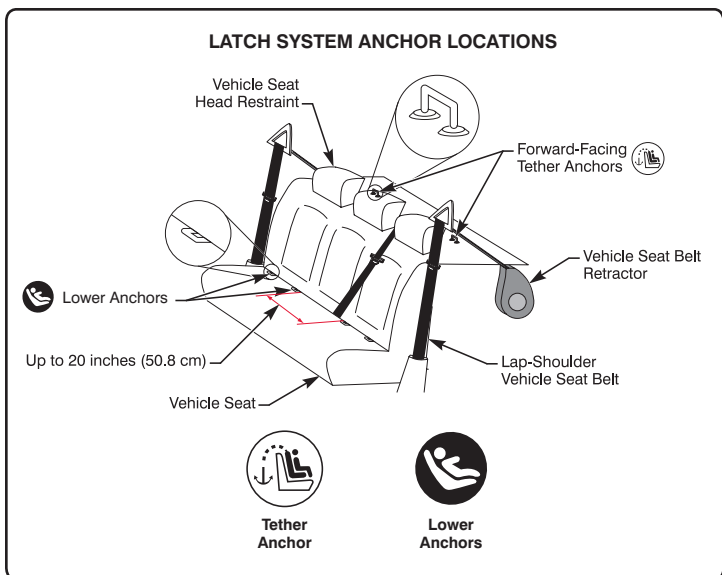

The figure above shows typical locations for lower anchors and tether anchors in a vehicle. Check your vehicle owner's manual to learn if it is equipped with LATCH, the maximum weight rating for the lower anchors, and for information on the lower anchor locations and seating positions available for use with this child seat.

Standard vehicle seat spacing between LATCH anchors is 11 in. (27.9 cm). This child seat can be used in a seating position with up to 20 in. (50.8 cm) of space between the LATCH anchors if the vehicle manufacturer allows.

Using the Lower Connectors

Where to find the Lower Connectors

The lower connectors are located in the back of the base of the child seat. Store the connectors in the slots when not in use.

To remove the lower connector from the storage slot or lower anchor:

- 1 Press and hold the red release button.

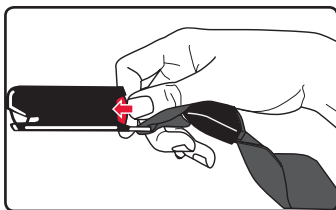

- 2 Pull the lower connector from the storage slot or lower anchor.

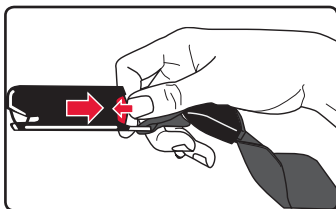

To attach the lower connector to the storage slot or lower anchor:

Firmly push the lower connector into the slot or lower anchor until a click is heard.

NOTE: The lower connectors store top down in the slots.

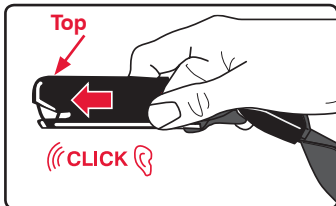

Using the Versa-Tether®



WARNING! Failure to follow the guidelines below may cause the child seat not to perform as intended:

- You **MUST** always use the Versa-Tether when using the child seat forward-facing. Using the tether will improve the stability of your child seat and reduce the risk of injury.
- Attach the Versa-Tether only to tether anchors identified by your vehicle manufacturer as tether anchorage points. Only use the designated tether anchor for each seating position.
- If your vehicle does not currently have a tether anchor attachment, refer to your vehicle owner's manual or contact your vehicle manufacturer for assistance. **DO NOT** modify your vehicle without advice from your vehicle manufacturer.
- Store the Versa-Tether in the pouch on the back of the child seat when not in use. **DO NOT** install the child seat with the Versa-Tether attached to the carry clip.

Tether anchor locations vary from vehicle to vehicle. Check your vehicle owner's manual and look for the tether anchor symbol shown in the diagram to help identify where the top tether anchor points are located in your vehicle. Britax recommends that the tether be used at all times when installing the child seat. Using the tether will improve the stability of your child seat and reduce the risk of injury. See the diagrams below for possible rear- and forward-facing Versa-Tether installation configurations.



Tether Configurations

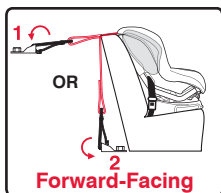

Rear-Facing Tether Connector Strap

Because every vehicle model is different, a location to anchor the tether for rear-facing installations may vary. Use the rear-facing tether connector strap to assist in creating an anchor point.

- 1 Find a fixed location in the vehicle that is bolted to the floor.
 - * If you cannot find a location to create an anchor point, contact the vehicle manufacturer to identify a tether connection point.
- 2 Route the strap through the anchor point.
- 3 Thread the metal D-ring through the loop on the end of the strap.
- 4 Pull the metal D-ring through until the strap is tight.
- 5 Use the D-ring as an attachment point for the tether.

NOTE: Store the tether connector strap in the tether pouch when not in use.

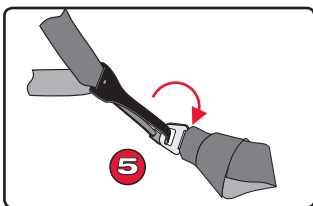

Attaching the Versa-Tether

IMPORTANT: The Versa-Tether® carry clip is only for use when you wish to carry the child seat between locations. **Do not install the child seat with the Versa-Tether attached to the carry clip.** Secure the excess Versa-Tether webbing in the elastic strap during use. Store the Versa-Tether in the storage pouch when not in use. Always ensure any excess webbing is contained within your vehicle.

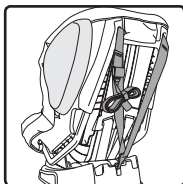

To attach the Versa-Tether to the carry clip or tether anchor:

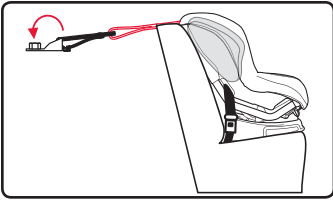

1 Firmly press the hook over the carry clip or tether anchor point.

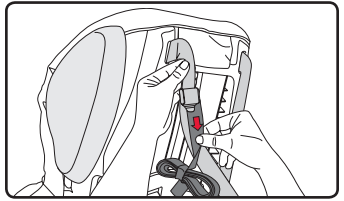

2 Pull the loose end of the webbing to remove slack from the Versa-Tether.

NOTE: When using as a carry strap, tighten until the strap is comfortable to carry.

To remove the Versa-Tether from the carry clip:

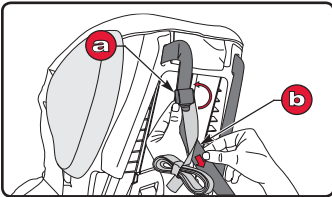

1 Loosen the Versa-Tether.
 a Tilt the lock up
 b Pull the tether webbing

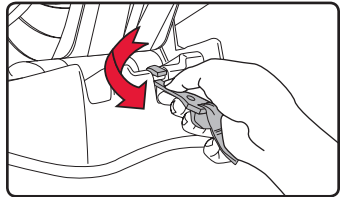

2 Remove the Versa-Tether® hook from the carry clip.

The Versa-Tether can indicate when the child seat has been in a moderate or severe crash (see page 3) and replacement of the child seat is necessary.

Figure 1 shows a tether acceptable for continued use (**provided the child seat has not been involved in a crash**). The colored stitching will be intact and not visible from the back of the seat.

Figures 2 and 3 show examples of when the tether has been damaged and is unacceptable for continued use. If one or both of the loops have pulled through the back of the shell and/or any of the colored stitching has ripped, the child seat is no longer acceptable for use.

IMPORTANT: Discontinue use of child seat if it has been involved in a moderate or severe crash, regardless of whether the loops have pulled through the back side of the shell and the colored stitching has been ripped.

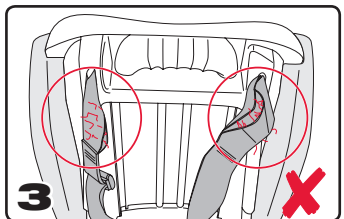
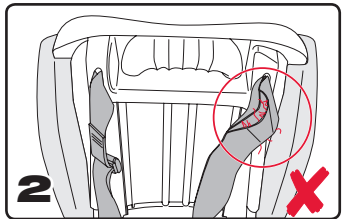
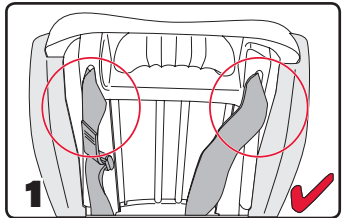

LATCH Installation

**Before You Begin:**

- Check that your vehicle has lower anchors.
 - * Refer to your vehicle owner's manual or contact the vehicle manufacturer for the maximum weight rating for their lower anchors. Use vehicle belt (not lower connectors) for installations with children who weigh more than the vehicle lower anchor limit. Unless specified otherwise by the vehicle manufacturer, assume a 40 lb (18.1 kg) child is the vehicle lower anchor limit.
- Remove the lower connectors from the storage slots in the base. Press the adjuster release button and pull the strap to full length. Repeat for the second strap.
- Recline this child seat to position 3 and place rear-facing on the vehicle seat (see page 15).
 - * When properly installed in the rear-facing position, the back angle of the child seat should be at least 30° for children and up to 45° from vertical for infants unable to maintain head and neck control (not to exceed 45°) when the car is parked on a level surface. Use the blue line as a guide to achieve the proper recline angle for rear-facing installations. The blue line will be parallel to the ground when the child seat angle is at the center of the angle range ($30 - 45^\circ$). If necessary, the proper recline angle can be achieved by placing a rolled towel or pool noodle in the vehicle seat bight.
- Britax recommends that the Versa-Tether is used at all times. Using the tether will improve the stability of the child seat and reduce the risk of injury. Check your vehicle owner's manual for tether anchor locations. See page 18 for possible rear-facing tether configurations.

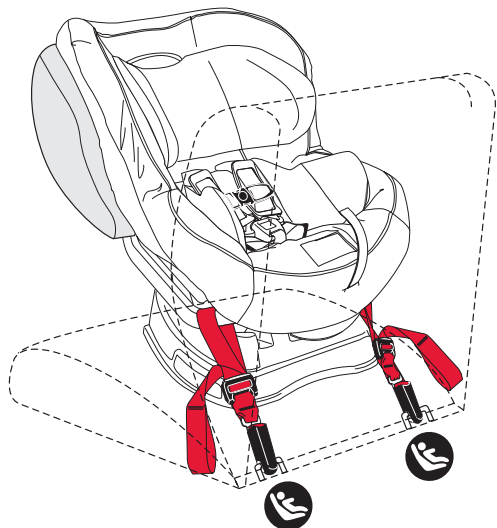
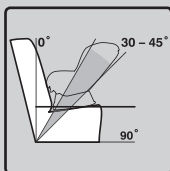

Install with the LATCH as shown above.

- 1 Firmly press the lower connectors onto the adjacent lower anchors.
 - A click confirms attachment.
 - Verify that the lower connector strap is not twisted.

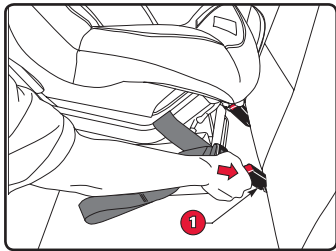

TIP: You may need to turn the front of the child seat toward you for easier access to the lower anchors.

NOTE: If a click is not heard when connecting either lower connector, the lower connector strap may be twisted, or there may be debris in the lower connector. Correct either situation before continuing with the installation process.

- 2 Push the child seat down while pulling each lower connector strap to tighten.
- 3 Rear-facing installations can be improved by the use of the Versa-Tether (see pages 17 – 19).

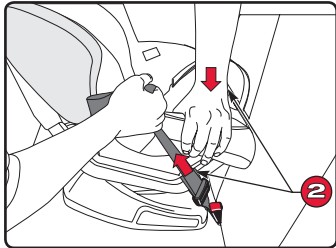

Checklist

- ✓ Check that all connections are secure.
- ✓ Check that the lower connector straps are not twisted.
- ✓ Check that the child seat cannot be moved front to back or side to side more than 1 in. (2.5 cm) at the belt path. If the child seat is not secure, repeat installation or use a different seating location.
- ✓ Check that the back angle of the child seat is 30° – 45° from vertical (not to exceed 45°) when the car is parked on a level surface.
 - * If necessary, the proper recline angle can be achieved by placing a rolled towel or pool noodle in the vehicle seat bight.

Lap-Shoulder Belt Installation

**Before You Begin:**

- Check that your vehicle belt is compatible for use with child seats. See pages 6 – 8 for more information.
- * If your vehicle seat belt system includes a locking feature, use of the lock-offs is not required as long as the vehicle seat belt system is locked. Check your vehicle owner's manual to determine how to lock your vehicle seat belt system when installing a child restraint.
- Recline this child seat to position 3 and place rear-facing on the vehicle seat (see page 15).
- * When properly installed in the rear-facing position, the back angle of the child seat should be at least 30° for children and up to 45° from vertical for infants unable to maintain head and neck control (not to exceed 45°) when the car is parked on a level surface. Use the blue line as a guide to achieve the proper recline angle for rear-facing installations. The blue line will be parallel to the ground when the child seat angle is at the center of the angle range (30 – 45°). If necessary, the proper recline angle can be achieved by placing a rolled towel or pool noodle in the vehicle seat bight.
- Britax recommends that the Versa-Tether is used at all times. Using the tether will improve the stability of the child seat and reduce the risk of injury. Check your vehicle owner's manual for tether anchor locations. See page 18 for possible rear-facing tether configurations.

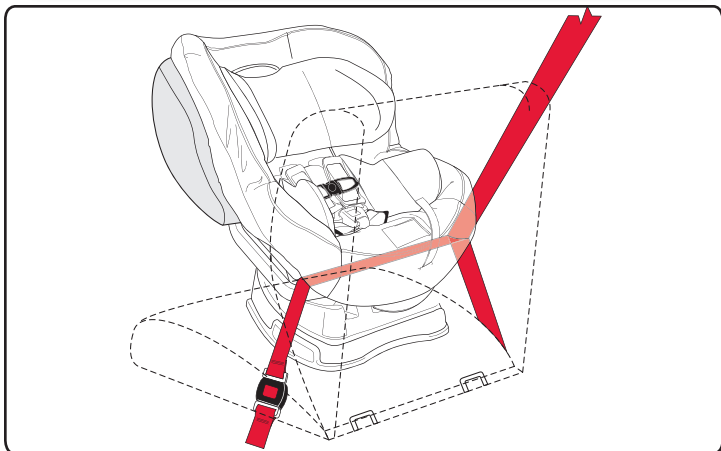
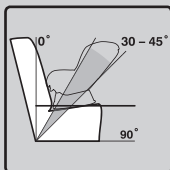

Install with the lap-shoulder belt as shown above.

IMPORTANT:

- The harness buckle strap should lie toward the back of the child seat during installation.
- The buckle should be in the inner slot for rear-facing installation.

- 1 Loosen the harness.
 - a Lift harness adjuster lever
 - b Pull both harness straps forward
- 2 Remove the body pillow, unbuckle the harness, and remove the belly pad.
- 3 Pull the head restraint cover up, then pull the seat cover forward while pulling the buckle through to access the rear-facing belt path.

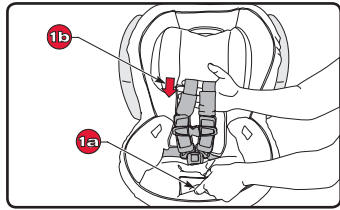

IMPORTANT: Ensure the buckle is in inner slot and lying away from the belt path.

- 4 Open the blue lock-off closest to where the vehicle belt will be buckled.
 - a Open the locking tab
 - b Open the clamp
- 5 Route the vehicle belt through the rear-facing belt slots, then buckle. Ensure the vehicle belt is not twisted.
- 6 Push down into the middle of the child seating area with moderate force while removing all slack from the bottom (lap) part of the vehicle belt and close the lock-off.

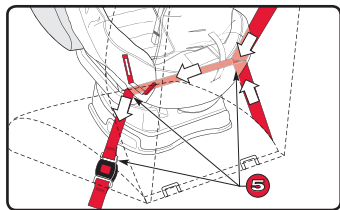
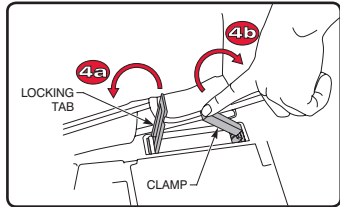

- a Close the clamp over the vehicle belt
- b Slide your palm or thumb along the locking tab until a click is heard (see page 14)

IMPORTANT: Both the vehicle lap and shoulder belts must be routed through the lock-off.

- 7 Push down into the middle of the child seating area with moderate force while pulling the top (shoulder) part of the belt between the belt slots to remove any remaining slack through the lock-off (see pages 6 and 7).
- 8 Rear-facing installations can be improved by the use of the Versa-Tether (see pages 17 – 19).
- 9 Pull the buckle up through its appropriate slot in the cover.
- 10 Replace the cover and the belly pad.

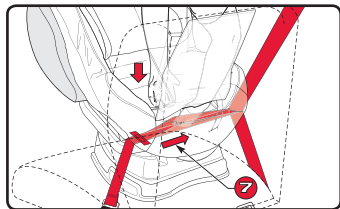

Checklist

- ✓ Check that the vehicle belt is securely fastened.
- ✓ Check that the child seat cannot be moved front to back or side to side more than 1 in. (2.5 cm) at the belt path. If the child seat is not secure, repeat installation or use a different seating location.
- ✓ Check that the back angle of the child seat is 30° – 45° from vertical (not to exceed 45°) when the car is parked on a level surface.
 - * If necessary, the proper recline angle can be achieved by placing a rolled towel or pool noodle in the vehicle seat bight.

Lap Belt Installation

**Before You Begin:**

- Check that your vehicle belt is compatible for use with child seats. See pages 6 – 8 for more information.
- Recline this child seat to position 3 and place rear-facing on the vehicle seat (see page 15).
- * When properly installed in the rear-facing position, the back angle of the child seat should be at least 30° for children and up to 45° from vertical for infants unable to maintain head and neck control (not to exceed 45°) when the car is parked on a level surface. Use the blue line as a guide to achieve the proper recline angle for rear-facing installations. The blue line will be parallel to the ground when the child seat angle is at the center of the angle range (30 – 45°). If necessary, the proper recline angle can be achieved by placing a rolled towel or pool noodle in the vehicle seat bight.
- Britax recommends that the Versa-Tether is used at all times. Using the tether will improve the stability of the child seat and reduce the risk of injury. Check your vehicle owner's manual for tether anchor locations. See page 18 for possible rear-facing tether configurations.

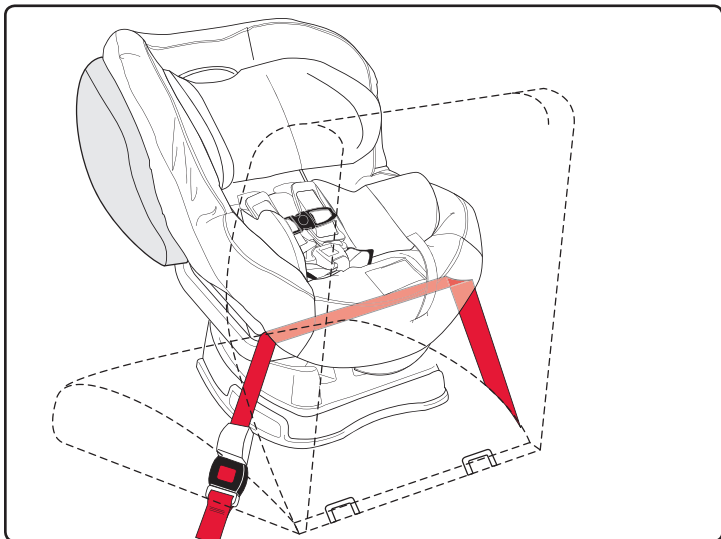
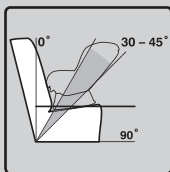

Install with the lap belt as shown above.

IMPORTANT:

- The harness buckle strap should lie toward the back of the child seat during installation.
- **DO NOT** use lock-offs for lap belt installations.
- The buckle should be in the inner slot for rear-facing installation.

- 1** Loosen the harness.
 - a Lift harness adjuster lever
 - b Pull both harness straps forward

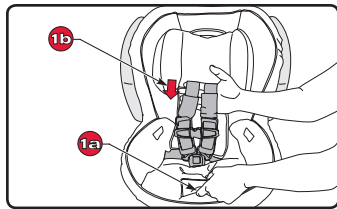

- 2** Remove the body pillow, unbuckle the harness, and remove the belly pad.

- 3** Pull the head restraint cover up, then pull the seat cover forward while pulling the buckle through to access the rear-facing belt path.

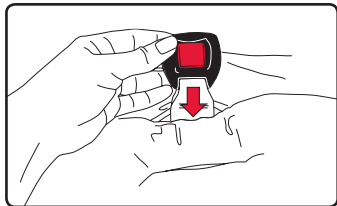

- 4** Route the vehicle seat belt through the rear-facing belt slots, then buckle. Ensure the vehicle belt is not twisted.

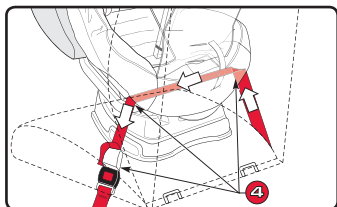

- 5** Push down on the middle of the the child seat while pulling the vehicle belt to remove all slack (see pages 7 and 8).

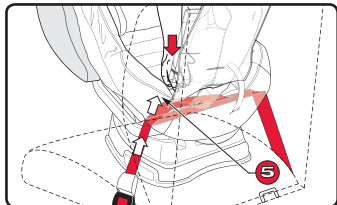

- 6** Rear-facing installations can be improved by the use of the Versa-Tether (see pages 17 – 19).

- 7** Pull the buckle up through its appropriate slot in the cover.

- 8** Replace the cover and belly pad.



Checklist

- ✓ Check that the vehicle belt is securely fastened.
- ✓ Check that the child seat cannot be moved front to back or side to side more than 1 in. (2.5 cm) at the belt path. If the child seat is not secure, repeat installation or use a different seating location.
- ✓ Check that the back angle of the child seat is 30° – 45° from vertical (not to exceed 45°) when the car is parked on a level surface.
 - * If necessary, the proper recline angle can be achieved by placing a rolled towel or pool noodle in the vehicle seat bight.

LATCH Installation



Before You Begin:

- *Check that your vehicle has lower anchors.*
 - * Refer to your vehicle owner's manual or contact the vehicle manufacturer for the maximum weight rating for their lower anchors. Use vehicle belt (not lower connectors) for installations with children who weigh more than the vehicle lower anchor limit. Unless specified otherwise by the vehicle manufacturer, assume a 40 lb (18.1 kg) child is the vehicle lower anchor limit.
- *Remove the lower connectors from the storage slots in the base. Press the adjuster release button and pull the lower connector strap to full length. Repeat for the second strap.*
- *Remove the Versa-Tether from the pouch and place it up and over the child seat back.*
 - * Britax recommends that the Versa-Tether is used at all times. Using the tether will improve the stability of the child seat and reduce the risk of injury. Check your vehicle owner's manual for tether anchor locations. Only attach the Versa-Tether to anchor points designated to the chosen seating position as indicated by your vehicle owner's manual.
- *Adjust this child seat to position 1 or 2 and place forward-facing on the vehicle seat (see page 15).*
 - * Ensure that no more than 20% or 3 in. (7.6 cm) of the base hangs over the edge of the vehicle seat.

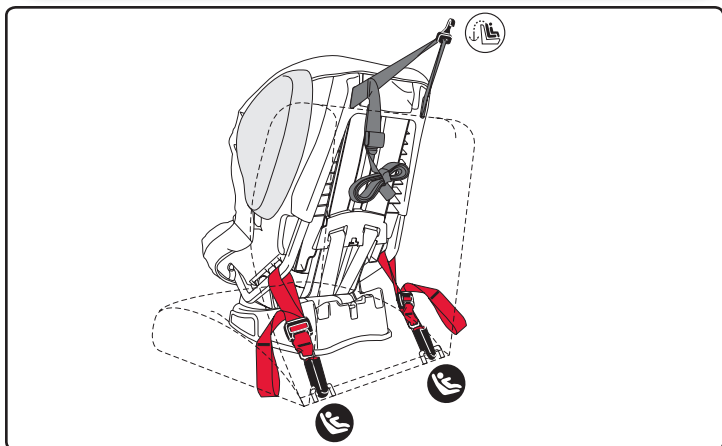

Install with the LATCH as shown above.



WARNING!

- *Your child seat may not perform as intended if the base of the child seat is not flat on the vehicle seat.*
- *Some vehicle head restraints may obstruct the harness adjuster from reaching the highest position. If this is the case, you may need to raise or remove the vehicle head restraint. **DO NOT** force the child seat head restraint past the vehicle head restraint. Doing so could cause the child seat not to perform as intended.*

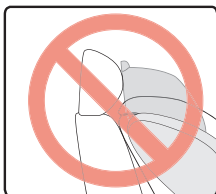

- 1 Firmly press the lower connectors onto the adjacent lower anchors.
 - A click confirms attachment.
 - Verify that the lower connector strap is not twisted.

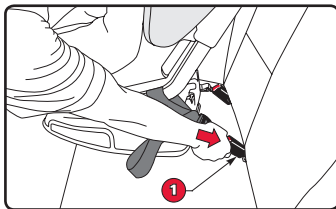

TIP: You may need to turn the back of the child seat toward you for easier access to the vehicle lower anchors.

NOTE: If a click is not heard when connecting either lower connector, the lower connector strap may be twisted, or there may be debris in the lower connector. Correct either situation before continuing with the installation process.

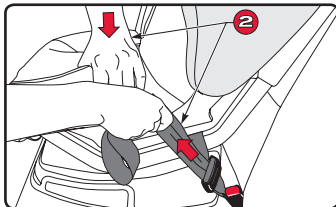

- 2 Push the child seat down while pulling each lower connector strap to tighten.
- 3 Attach the Versa-Tether to a designated anchor (see vehicle owner's manual) and remove slack (see pages 17 – 19).
- 4 Store excess webbing in the elastic strap.

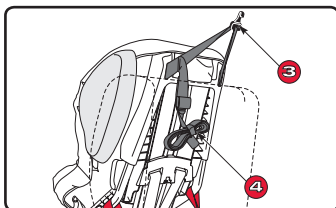

Checklist

- ✓ Check that all connections are secure.
- ✓ Check that the lower connector straps are not twisted.
- ✓ Check that no more than 20% or 3 in. (7.6 cm) of the base hangs over the edge of the vehicle seat.
- ✓ Check that the child seat cannot be moved front to back or side to side more than 1 in. (2.5 cm) at the belt path. If the child seat is not secure, repeat installation or use a different seating location.
- ✓ Check that any excess Versa-Tether® webbing is contained within your vehicle and secured in the elastic strap.

Lap-Shoulder Belt Installation



Before You Begin:

- Check that your vehicle belt is compatible for use with child seats. See pages 6 – 8 for more information.
 - * If your vehicle seat belt system includes a locking feature, use of the lock-offs is not required as long as the vehicle seat belt system is locked. Check your vehicle owner's manual to determine how to lock your vehicle seat belt system when installing a child restraint.
- Remove the Versa-Tether from the pouch and place it up and over the child seat back.
 - * Britax recommends that the Versa-Tether is used at all times. Using the tether will improve the stability of the child seat and reduce the risk of injury. Check your vehicle owner's manual for tether anchor locations. Only attach the Versa-Tether to anchor points designated to the chosen seating position as indicated by your vehicle owner's manual.
- Adjust this child seat to position 1 or 2 and place forward-facing on the vehicle seat (see page 15).
 - * Ensure that no more than 20% or 3 in. (7.6 cm) of the base hangs over the edge of the vehicle seat.

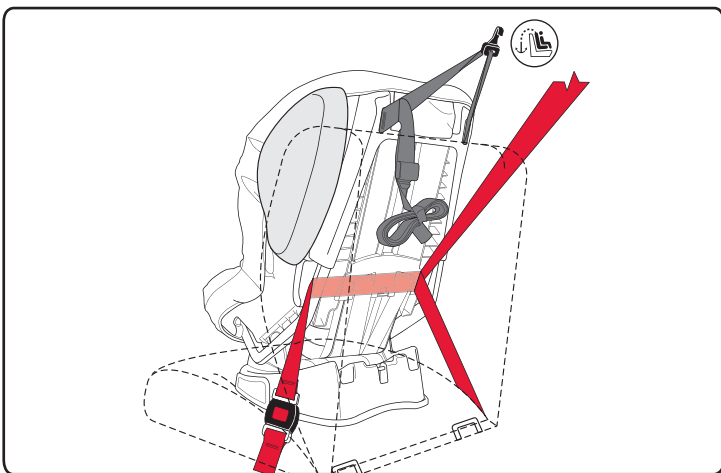

Install with the lap-shoulder belt as shown above.



WARNING!

- Your child seat may not perform as intended if the base of the child seat is not flat on the vehicle seat.
- Some vehicle head restraints may obstruct the harness adjuster from reaching the highest position. If this is the case, you may need to raise or remove the vehicle head restraint. **DO NOT** force the child seat head restraint past the vehicle head restraint. Doing so could cause the child seat not to perform as intended.



- 1** Loosen the harness.
 - a Lift harness adjuster lever
 - b Pull both harness straps forward
- 2** Remove the body pillow and unbuckle the harness.
- 3** Pull the head restraint cover up, then pull the seat cover forward to access the forward-facing belt path.
- 4** Open the red lock-off closest to where the vehicle belt will be buckled.
 - a Open the locking tab
 - b Open the clamp
- 5** Route the vehicle belt through the forward-facing belt slots, then buckle. Ensure the vehicle belt is not twisted.

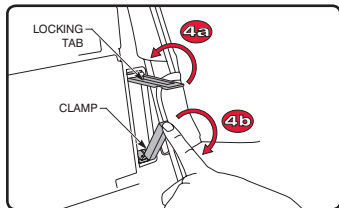
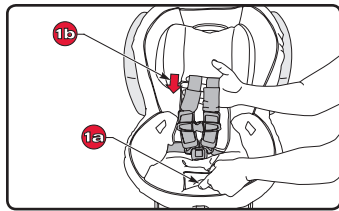

- 6** Push down into the rear of the child seating area with moderate force while removing all slack from the bottom (lap) part of the vehicle belt and close the lock-off.
 - a Close the clamp over the vehicle belt
 - b Slide your palm or thumb along the locking tab until a click is heard (see page 14)

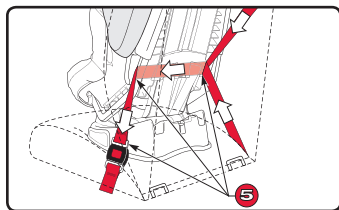

IMPORTANT: Both the vehicle lap and shoulder belts must be routed through the lock-off.

- 7** Push down into the middle of the child seating area with moderate force while pulling the top (shoulder) part of the belt between the belt slots to remove any remaining slack through the lock-off (see pages 6 and 7).
- 8** Attach the Versa-Tether to a designated anchor (see vehicle owner's manual) and remove all slack (see pages 17 – 19).
- 9** Store the excess webbing in the elastic strap.
- 10** Replace the cover.

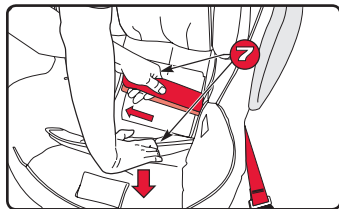

Checklist

- ✓ Check that the vehicle belt is securely fastened.
- ✓ Check that no more than 20% or 3 in. (7.6 cm) of the base hangs over the edge of the vehicle seat.
- ✓ Check that the child seat cannot be moved front to back or side to side more than 1 in. (2.5 cm) at the belt path. If the child seat is not secure, repeat installation or use a different seating location.
- ✓ Check that any excess Versa-Tether® webbing is contained within your vehicle and secured in the elastic strap.

Lap Belt Installation



Before You Begin:

- Check that your vehicle belt is compatible for use with child seats. See pages 6 – 8 for more information.
- Remove the Versa-Tether from the pouch and place it up and over the child seat back.
 - * Britax recommends that the Versa-Tether is used at all times. Using the tether will improve the stability of the child seat and reduce the risk of injury. Check your vehicle owner's manual for tether anchor locations. Only attach the Versa-Tether to anchor points designated to the chosen seating position as indicated by your vehicle owner's manual.
- Adjust this child seat to position 1 or 2 and place forward-facing on the vehicle seat (see page 15).
 - * Ensure that no more than 20% or 3 in. (7.6 cm) of the base hangs over the edge of the vehicle seat.

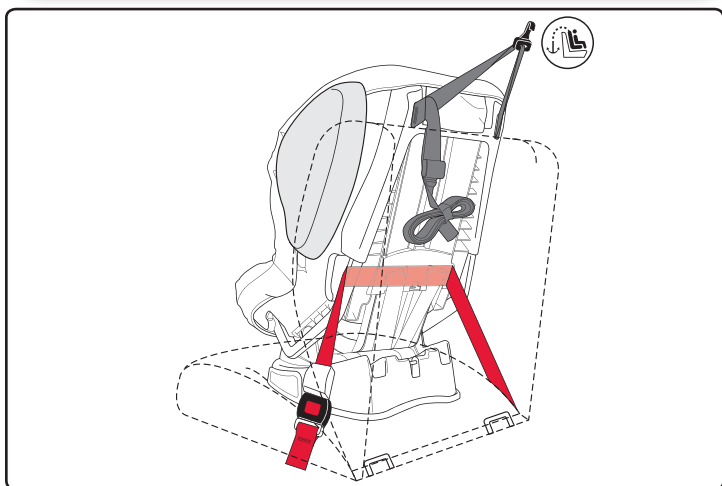

Install with the lap belt as shown above.

IMPORTANT:

- **DO NOT** use lock-offs for lap belt installations.



WARNING!

- Your child seat may not perform as intended if the base of the child seat is not flat on the vehicle seat.
- Some vehicle head restraints may obstruct the harness adjuster from reaching the highest position. If this is the case, you may need to raise or remove the vehicle head restraint. **DO NOT** force the child seat head restraint past the vehicle head restraint. Doing so could cause the child seat not to perform as intended.

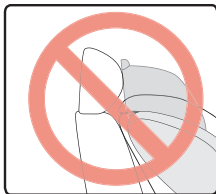

- 1** Loosen the harness.
 - a Lift harness adjuster lever
 - b Pull both harness straps forward
- 2** Remove the body pillow and unbuckle the harness.
- 3** Pull the head restraint cover up, then pull the seat cover forward to access the forward-facing belt path.
- 4** Route the vehicle seat belt through the forward-facing belt slots, then buckle. Ensure the vehicle belt is not twisted.
- 5** Push down on the middle of the the child seat while pulling the vehicle belt to remove all slack (see pages 7 and 8).
- 6** Attach the Versa-Tether to a designated anchor (see vehicle owner's manual) and remove slack (see pages 17 – 19).
- 7** Store the excess webbing in the elastic strap.
- 8** Replace the cover.

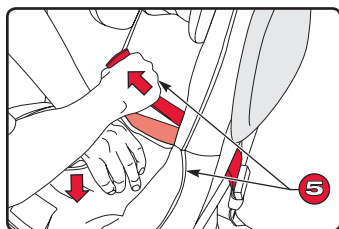
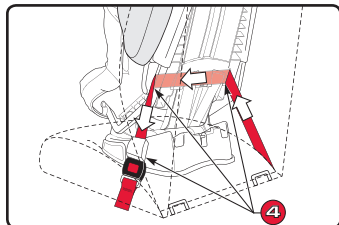
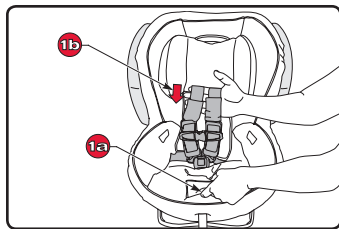

Checklist

- ✓ Check that the vehicle belt is securely fastened.
- ✓ Check that no more than 20% or 3 in. (7.6 cm) of the base hangs over the edge of the vehicle seat.
- ✓ Check that the child seat cannot be moved front to back or side to side more than 1 in. (2.5 cm) at the belt path. If the child seat is not secure, repeat installation or use a different seating location.
- ✓ Check that any excess Versa-Tether® webbing is contained within your vehicle and secured in the elastic strap.

Aircraft Installation



Certified for Aircraft Travel

This child seat is certified for aircraft use. Most airlines in Canada and the U.S. will allow the use of a child seat as long as it is labeled as an approved child seat for use in aircraft and fits properly on the aircraft seat. Contact the airline about their policy prior to traveling.

The FAA recommends that a child weighing up to 40 lbs (18.1 kg) use a certified, harnessed child seat while traveling on an aircraft.

Install your child seat in a window seat to avoid blocking the aisle.

Rear-Facing Installation

For rear-facing aircraft installation (Fig. A), follow [Rear-Facing Lap Belt Installation](#) instructions on pages 24 – 25.

Forward-Facing Installation

For forward-facing aircraft installation (Fig. B), follow [Forward-Facing Lap Belt Installation](#) instructions on pages 30 – 31.

If the aircraft lap belt is too short, ask a flight attendant for a belt extender.

NOTE: *Your child may experience discomfort if the buckle is located in the seating area of the child seat after installation.*

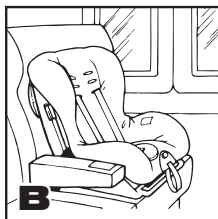
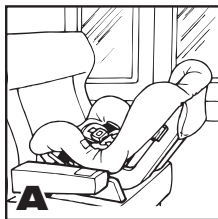

WARNING! *Inflatable lap belts are **NOT** compatible with this child seat.*

Securing Your Child



WARNING!

- *Adjust the belts provided with this child seat so they fit snugly around your child. A snug strap should not allow any slack. It lies in a relatively straight line without sagging. It does not press on the child's flesh or push the child's body into an unnatural position.*
- *Adjust the harness to fit the clothes the child is wearing. Remove bulky coats and/or jackets before putting the child in the child seat.*
- *The HUGS™ chest pads must be used at all times when installing the child seat forward-facing.*
- *Verify that the child seat is secure and the harness is properly adjusted around the child **each** time the child seat is used.*



Before You Begin:

- *Follow the instructions on page 13 to make the proper adjustments to the harness and buckle.*

- 1 **Loosen the harness.**
 - a Lift harness adjuster lever
 - b Pull both harness straps forward
- 2 **Open the chest clip.**
 - a Press tabs
 - b Pull apart
- 3 **Release the buckle and attach the harness straps to the harness holders.**
- 4 **Place the child in the child seat.**
 - * Ensure the child is positioned upright in the child seat and not slouching. Their bottom must touch the child seat, and their back must rest flat against the back of the child seat.
- 5 **Position the harness straps around the child.**
- 6 **Fasten the harness buckle.**
 - * Proper connection is confirmed with a click after inserting each buckle tongue.
- 7 **Pull the excess slack up to the child's shoulder area while moving the HUGS™ chest pads down toward the buckle.**
- 8 **Pull the harness adjuster strap up and away from the child seat to tighten the harness. **The Click & Safe® indicator will click when the harness is within range of appropriate snugness.****
 - * The harness should have a comfortable but snug fit around the child. A snug strap should not allow any slack. It lies in a relatively straight line without sagging. It does not press on the child's flesh or push the child's body into an unnatural position. You should not be able to pinch excess.
- 9 **Fasten the chest clip.**
 - * The correct height for the chest clip is at the middle of the chest at armpit level.
 - * The HUGS™ chest pads may be placed in any position that is comfortable for the child within the range of the correctly placed chest clip.

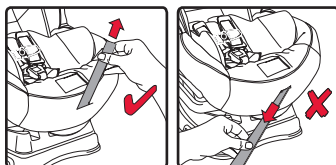
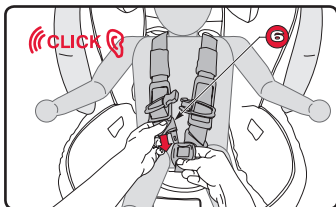
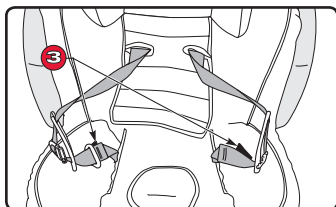
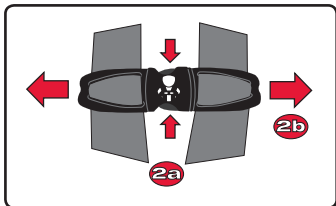
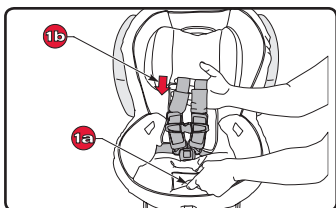

✓ Pull the harness adjuster strap up and away from the child seat to tighten.

✗ Do not pull sideways.

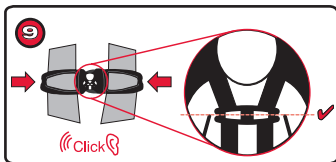

Checklist

Before traveling, verify that the:

- ✓ Harness straps are not twisted.
- ✓ Harness is snug.
- ✓ Buckle is fastened.
- ✓ Chest clip is at the child's armpit level.

Removing the Cover



WARNING!

- Never remove the buckle tongues from the harness. They cannot be reattached after removal. If reassembled incorrectly, the child seat may not perform as intended.
- DO NOT remove the HUGS™ chest pads from the harness straps.

1 Loosen the harness.

- Lift release lever
- Pull both harness straps forward

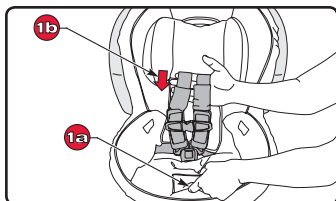

2 Open the chest clip.

- Press tabs
- Pull apart

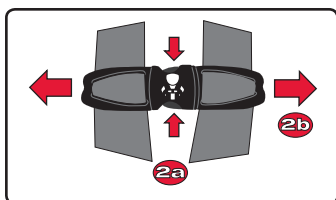

3 Unbuckle the harness.

4 Remove the infant body pillow if necessary.

5 Remove the belly pad from the harness buckle.

- Pull the buckle through the belly pad
- Remove the elastic strap from around the buckle

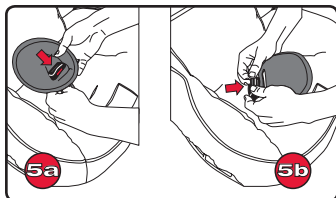

6 Detach the hook and loop fasteners on the head restraint cover from around the harness.

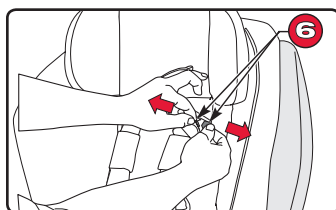

7 Raise the harness to the highest position and detach the hook and loop fasteners on the head restraint cover from around the head restraint.

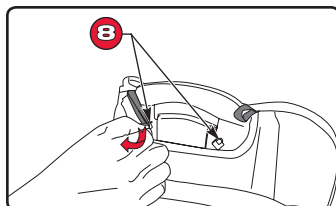

8 Detach the elastic straps from the tabs behind the harness height adjuster.

9 Remove the head restraint cover.

10 Detach the plastic hooks from the bottom edge of the child seat.

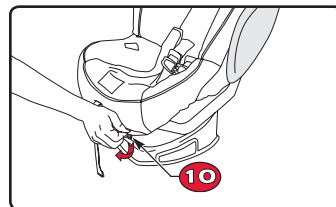

- 11** Adjust the harness to the lowest position.
- 12** Detach the plastic hooks from the back of the child seat shell.

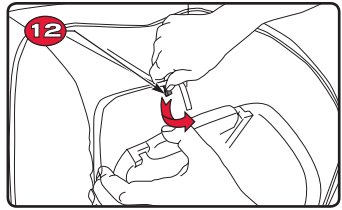

- 13** Push the buckle through the slot in the cover.

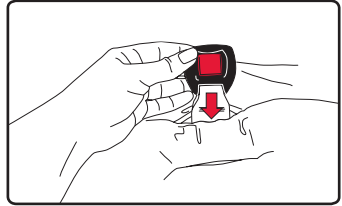

- 14** Pull the cover fabric from between the Side Impact Cushion and child seat shell.

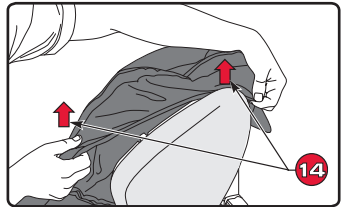

- 15** Remove the cover from the child seat shell.

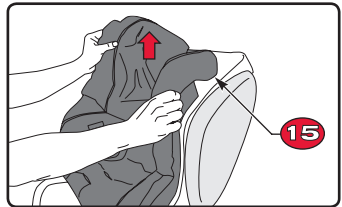

Cleaning the Cover

- HAND WASH the cover using cold water and mild soap.
- LINE DRY to prevent the cover from shrinking.
- **DO NOT:**
 - * Bleach
 - * Machine wash
 - * Machine dry
 - * Iron

Cleaning the Harness

- SPONGE CLEAN the harness using warm water and mild soap.
- TOWEL DRY
- **DO NOT:**
 - * Disassemble the harness
 - * Bleach
 - * Machine wash
 - * Machine dry
 - * Iron

Cleaning the Shell

- SPONGE CLEAN the shell using warm water and mild soap.
- TOWEL DRY
- **DO NOT** use abrasive cleaners

Cleaning the Side Impact Cushions

- SPONGE CLEAN the cushion using warm water and mild soap.
- TOWEL DRY
- **DO NOT** use abrasive cleaners



WARNING: Prevent the Side Impact Cushions from being punctured. Puncture damage will cause the cushions not to perform as intended!

Replacing the Cover

- 1 *Fit the child seat cover around the child seat shell.*

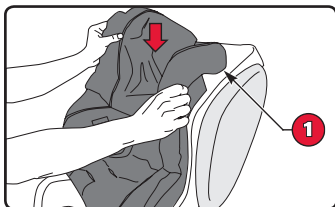

- 2 *Pull the cover fabric tight and slide it between the child seat shell and Side Impact Cushion.*

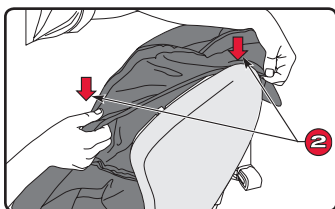

- 3 *Attach the plastic hooks on the cover to the back of the child seat shell.*

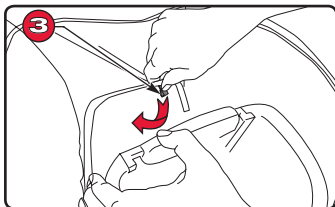

- 4** Attach the plastic hooks to the bottom edge of the child seat.

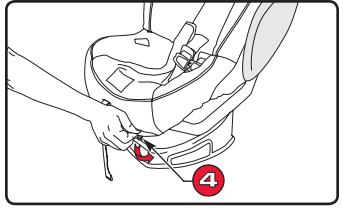

- 5** Pull the buckle through the slot in the cover.
 * Ensure that the buckle is through the correct cover slot for the buckle position.

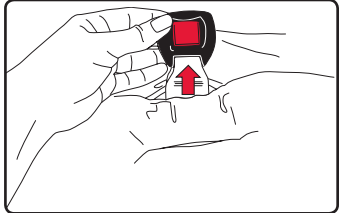

- 6** Fit the head restraint cover around the harness height adjuster and attach the elastic straps to the rear tabs.

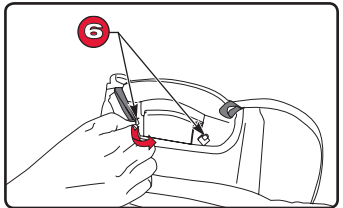

- 7** Attach the hook and loop fasteners on the head restraint cover around the head restraint.

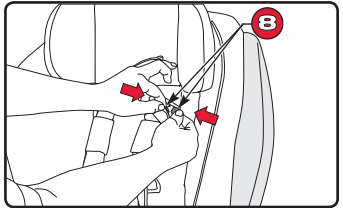

- 8** Attach the hook and loop fasteners on the head restraint cover around the harness.

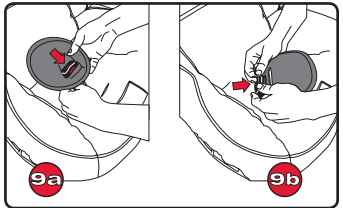

- 9** Replace the belly pad.
 a Pull the elastic strap around the buckle
 b Push the buckle through the belly pad

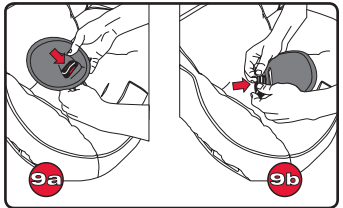

Cleaning the Buckle

If your child eats and drinks while in the child seat, you will need to check the buckle periodically and rinse out any accumulated debris.

Removing the Buckle

- 1 *Unbuckle the harness. Remove the belly pad and push the buckle through the cover.*

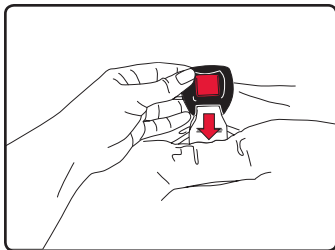

- 2 *Turn the buckle webbing and slide it between buckle positions.*

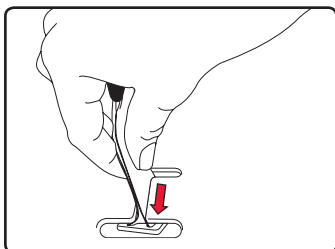

- 3 *Guide the buckle retainer up through the slot in the child seat shell to remove.*

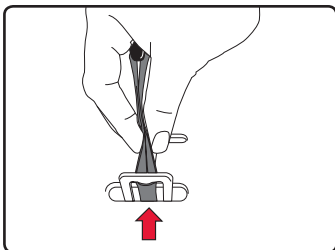

To Clean:

- THOROUGHLY RINSE the buckle using warm water.
- TEST THE BUCKLE by fastening and unfastening until a click is heard after inserting each buckle tongue. If clicks are not heard, repeat the cleaning procedure.
- TOWEL DRY
- **DO NOT:**
 - * Soak
 - * Lubricate
 - * Use solvents
 - * Use soap or household detergents

Replacing the Buckle

IMPORTANT:

- ALWAYS position the buckle in the inner slot for rear-facing use when using a vehicle seat belt installation.
- The vehicle belt must pass in front of the buckle strap for rear-facing use.
- Position the buckle in the slot closest to but not under the child for rear-facing use when using the LATCH installation.
- NEVER leave the buckle in the adjustment slot.
- Use the outer buckle slot when installing the child seat forward-facing with a child weighing 30 lbs (13.6 kg) and above or if the buckle is under the child in the inner position.

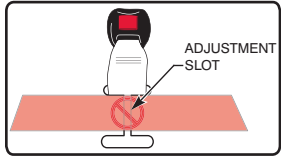

- 1** Guide the buckle retainer down through the slot in the child seat shell.

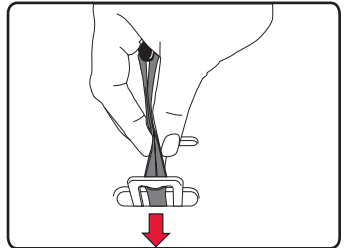

- 2** Slide the buckle webbing into the slot between buckle positions.

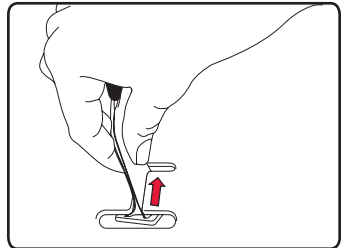

- 3** Select the appropriate slot for the size of your child and turn the buckle webbing and slide it into the chosen slot.

- 4** Ensure that the buckle strap is not twisted and that the button faces out.

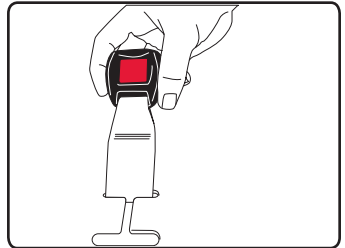

Troubleshooting

Problem: The harness cannot be adjusted to its full height.

Possible Solution: Check the seating position where the child seat is installed. The vehicle head restraint may obstruct the path of the child seat harness height adjuster. Remove or raise the vehicle head restraint and try adjusting the harness height again.

Problem: The harness is hard to adjust.

Possible Solution: The yoke may be caught on the Versa-Tether® webbing or other component of the child seat. Remove the obstruction and try adjusting the harness again. Always store the Versa-Tether in the pouch provided when not in use. When the Versa-Tether is in use, always secure excess webbing in the elastic strap. See pages 17 – 19.

Possible Solution: The vehicle seat back may hinder harness adjustment. Ensure the child seat base is flat on the vehicle seat.

Possible Solution: The harness may be at maximum or minimum height, the harness may be too tight to adjust, or the child's weight may be pressing against the head restraint. Check for and correct all of the above where necessary and try adjusting the harness again.

Problem: The adjuster strap is fraying at the sides.

Possible Solution: Pull the harness adjuster strap up and away from the child seat to tighten. Do not pull sideways. Doing so may cause the harness adjuster strap to fray at the sides. See page 33.

Problem: The buckle will not fasten with a click after each tongue is inserted.

Possible solution: There may be debris in the buckle mechanism. Clean the buckle as shown on page 38 and try fastening the buckle again.

Please contact Consumer Services at 1.888.427.4829 if you have an issue not listed here.

This child seat was manufactured by Britax Child Safety, Inc. Britax® warrants this product to the original retail purchaser as follows:

LIMITED ONE-YEAR WARRANTY

This product is warranted against defective materials or workmanship for one year from the date of original purchase. Proof of purchase is required. Your exclusive remedy for this warranty is that Britax will, at its option, provide repair or replacement components for this product. Britax reserves the right to discontinue or change fabrics, parts, models or products, or to make substitutions.

To make a claim under this warranty, you must contact Britax Consumer Services at 1-888-427-4829 or write to us using the address on the back cover of this booklet.

PLEASE COMPLETE AND MAIL THE OWNER REGISTRATION CARD WITHIN (30) DAYS OF PURCHASE

You may also register online at www.BritaxUSA.com/registration.

WARRANTY LIMITATIONS

This warranty does not include damages which arise from negligence, misuse or use not in accordance with the product instruction.

The use of non-Britax Child Safety, Inc. covers, inserts, toys, accessories, or tightening devices is not approved by Britax. Their use could cause this child seat to fail Federal Motor Vehicle Safety Standards or not perform as intended in a crash. Their use automatically voids the Britax warranty.

LIMITATION OF DAMAGES

The warranty and remedies as set forth above are exclusive and in lieu of all others, oral or written, express or implied. In no event will Britax, or the retailer selling this product, be liable to you for any damages, including incidental or consequential damages, arising out of the use or inability to use this product.

LIMITATIONS OF WARRANTIES AND OTHER WARRANTY TERMS AND STATE LAWS

Any implied warranties, including implied warranties of merchantability and fitness for a particular purpose, shall be limited to the duration and terms of the express written warranty. Some states do not allow limitations on how long an implied warranty lasts or the exclusion or limitation of incidental or consequential damages, so the above limitations may not apply to you. This warranty gives you specific legal rights, and you may have other rights, which vary from state to state. Neither Britax, nor the retailer selling this product, authorizes any person to create for it any other warranty, obligation, or liability in connection with this product.

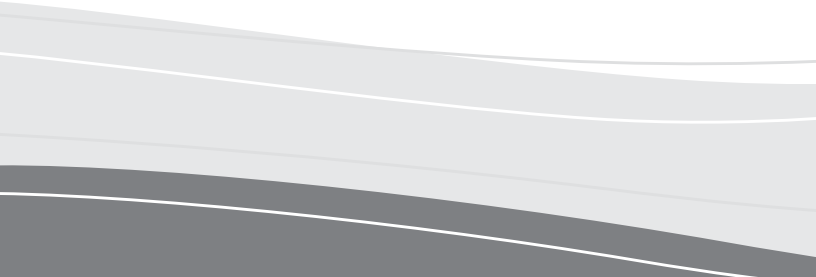

Britax Child Safety, Ltd.
P.O. Box 7289,
RPO Brunswick Square,
Saint John NB E2L 4S6

A **Britax Childcare Group
Limited** company

Une société de **Britax Childcare
Group Limited**

Tel. : 1-888-427-4829

www.Britax.ca